

PANNELLO DA 930x1992 kg/cad zn. 16,27 (kg/m² 8,78)
 #62x132
 PIATTO VERTICALE 25x2
 TONDO ORIZZONTALE Ø4,5
 CORNICE 25x4

PIANTANA Ø50 lg. 1210 (da inghisare) kg/cad zn. 3,1

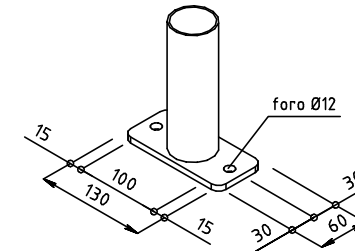
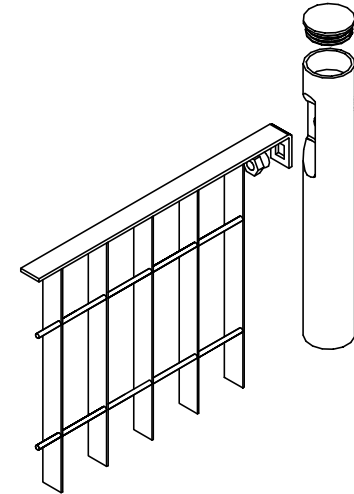
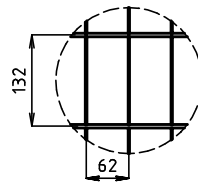

PIANTANA Ø50 lg. 1083 (da tassellare) kg/cad zn. 3,3
 DIMENSIONE PIASTRA 130x60x7

1	09-07-2013	MODIFICATO Ø TONDO ORIZZONTALE DA 5 A 4,5	BROGGI	M.G.
0	23-02-2013	PRIMA EMISSIONE	MARZORATI	M.G.
REVISIONE REVISION	DATA/DATE	DESCRIZIONE/DESCRIPTION	DIS./PREPARED	APPROV./APPROVED
			STEROPE 2 PANNELLO h.930x1992 PIANTANA Ø50 lg.1210/1083	
22040 ANZANO DEL PARCO (CO) - Italia Tel. 031 63.32.211 r.a. - Fax. 031 63.32.233 www.nuovodefim.com e-mail: orsogril@nuovodefim.com			ST2011 1 REVISIONE/REVISED Ø1	
CLIENTE CUSTOMER			Nuova Defim - Orsogril	
QUESTO DISEGNO È DI PROPRIETÀ DELLA NUOVA DEFIM - ORSOGRIL ED È VINCOLATO SECONDO LE NORME DI LEGGE. THIS DRAWING IS THE PROPERTY OF NUOVA DEFIM - ORSOGRIL WHO WILL SAFEGUARD ITS RIGHTS ACCORDING TO THE CIVIL AND PENAL PROVISIONS OF THE LAW.				SCALA SCALE
Disegno eseguito con CAD. Non Revisionare manualmente./Drawing made by CAD. Do not modify manually.				1/15

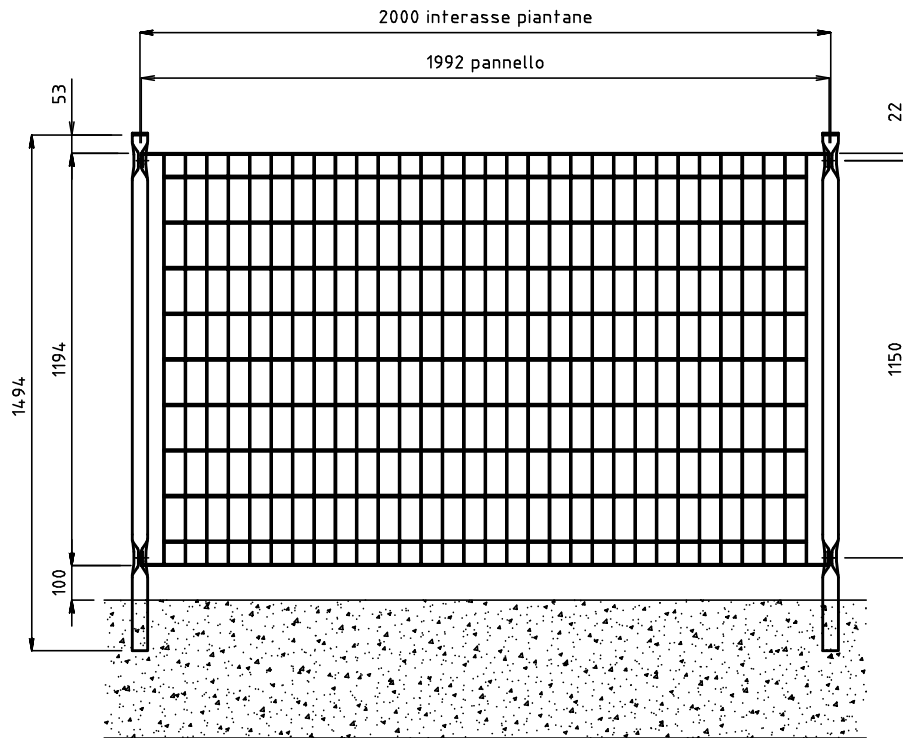

PANNELLO DA 1194x1992 kg/cad zn. 19,96 (kg/m² 8,39)
 #62x132
 PIATTO VERTICALE 25x2
 TONDO ORIZZONTALE Ø4,5
 CORNICE 25x4

PIANTANA Ø50 lg. 1494 (da inghisare) kg/cad zn. 3,9

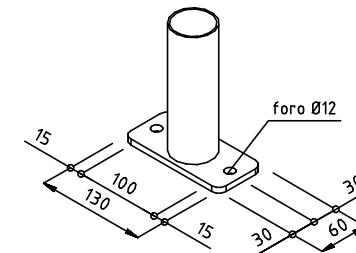
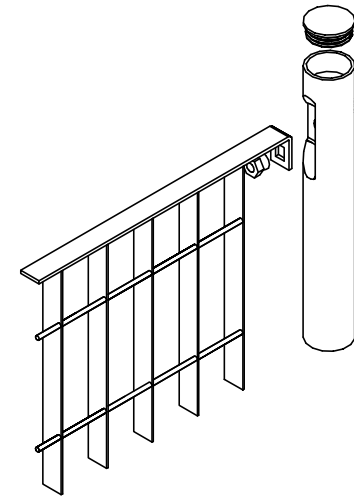
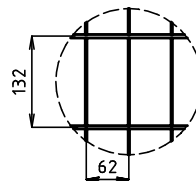

PIANTANA Ø50 lg. 1347 (da tassellare) kg/cad zn.4,0
 DIMENSIONE PIASTRA 130x60x7

1	09-07-2013	MODIFICATO Ø TONDO ORIZZONTALE DA 5 A 4,5	BROGGI	M.G.
0	23-02-2013	PRIMA EMISSIONE	MARZORATI	M.G.
REVISIONE REVISION	DATA/DATE	DESCRIZIONE/DESCRIPTION	DIS./PREPARED	APPROV./APPROVED
			STEROPE 2 PANNELLO h.1194x1992 PIANTANA Ø50 lg.1494/1347	
22040 ANZANO DEL PARGO (CO) - Italia Tel. 031 63.32.211 r.a. - Fax. 031 63.32.233 www.nuovodefim.com e-mail: orsogril@nuovodefim.com			ST2012 1 REVISIONE/REVISED 01	
CLIENTE/CUSTOMER: Nuova Defim - Orsogril			SCALA/SCALE: 1/15	

QUESTO DISEGNO E' DI PROPRIETA' DELLA NUOVA DEFIM - ORSOGRIL ED E' VINCOLATO SECONDO LE NORME DI LEGGE.
 THIS DRAWING IS THE PROPERTY OF NUOVA DEFIM - ORSOGRIL WHO WILL SAFEGUARD ITS RIGHTS ACCORDING TO THE CIVIL AND PENAL PROVISIONS OF THE LAW.

Disegno eseguito con CAD. Non Revisionare manualmente./Drawing made by CAD. Do not modify manually.

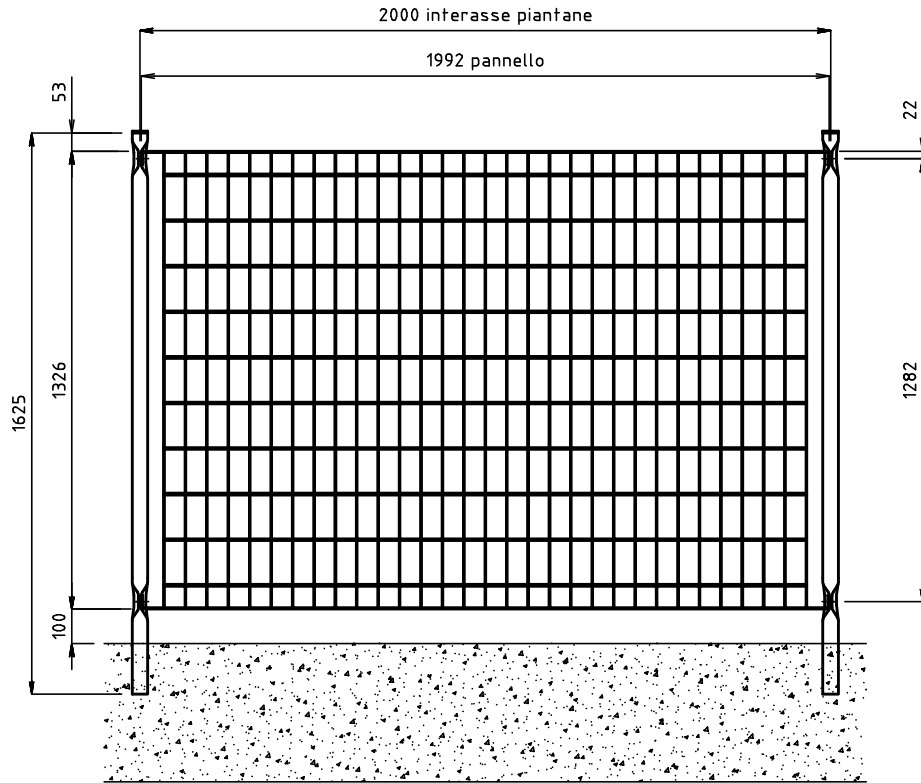

PANNELLO DA 1326x1992 kg/cad zn. 21,82 (kg/m² 8,26)
 #62x132
 PIATTO VERTICALE 25x2
 TONDO ORIZZONTALE Ø4,5
 CORNICE 25x4
 PIANTANA Ø50 lg. 1625 (da inghisare) kg/cad zn. 4,2

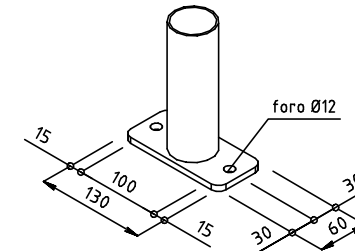
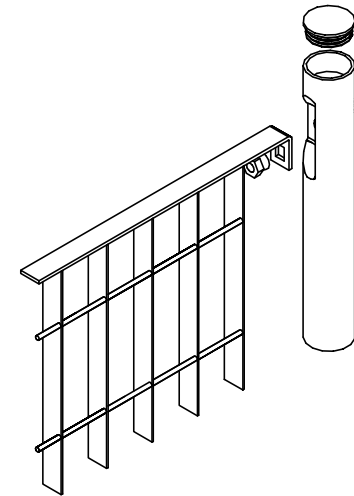
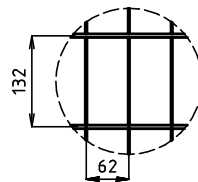

PIANTANA Ø50 lg. 1479 (da tassellare) kg/cad zn. 4,4
 DIMENSIONE PIASTRA 130x60x7

1	09-07-2013	MODIFICATO Ø TONDO ORIZZONTALE DA 5 A 4,5	BROGGI	M.G.
0	23-02-2013	PRIMA EMISSIONE	MARZORATI	M.G.
REVISIONE REVISION	DATA/DATE	DESCRIZIONE/DESCRIPTION	DIS./PREPARED	APPROV./APPROVED
			STEROPE 2 PANNELLO h.1326x1992 PIANTANA Ø50 lg.1625/1479	
22040 ANZANO DEL PARGO (CO) - Italia Tel. 031 63.32.211 r.a. - Fax. 031 63.32.233 www.nuovodefim.com e-mail: orsogril@nuovodefim.com			ST2013 1 REVISIONE/REVISED 01	
CLIENTE CUSTOMER			Nuova Defim - Orsogril	
QUESTO DISEGNO E' DI PROPRIETA' DELLA NUOVA DEFIM - ORSOGRIL ED E' VINCOLATO SECONDO LE NORME DI LEGGE. THIS DRAWING IS THE PROPERTY OF NUOVA DEFIM - ORSOGRIL WHO WILL SAFEGUARD ITS RIGHTS ACCORDING TO THE CIVIL AND PENAL PROVISIONS OF THE LAW.				SCALA SCALE 1/15

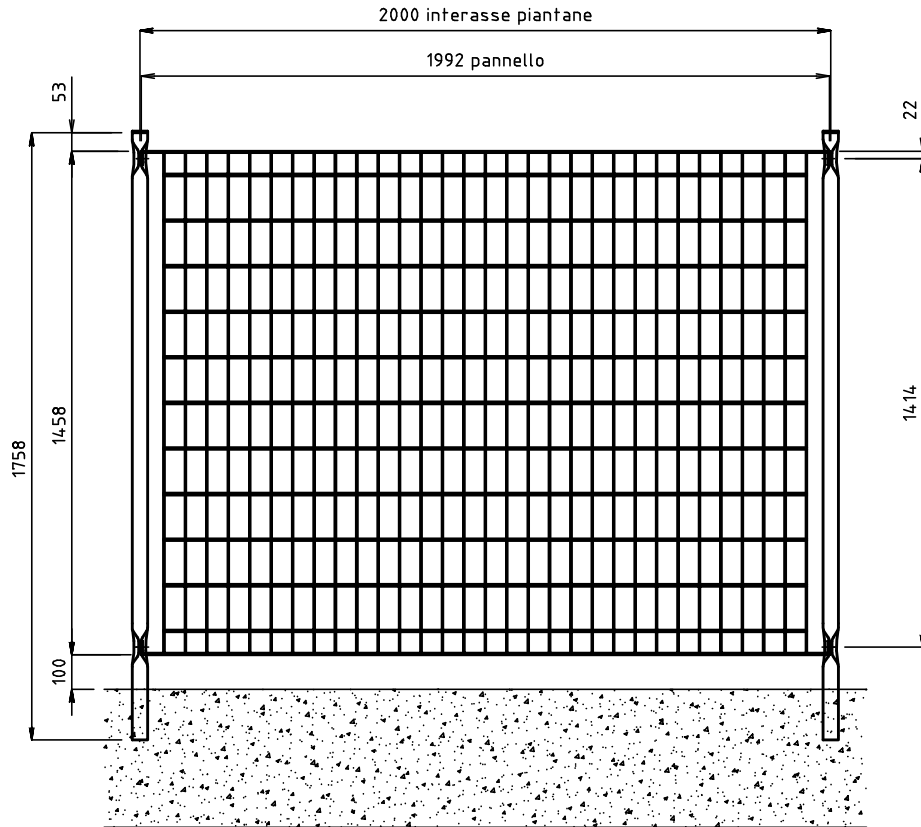

PANNELLO DA 1458x1992 kg/cad zn. 23,64 (kg/m² 8,14)
 #62x132
 PIATTO VERTICALE 25x2
 TONDO ORIZZONTALE Ø4,5
 CORNICE 25x4
 PIANTANA Ø50 lg. 1758 (da inghisare) kg/cad zn. 4,6

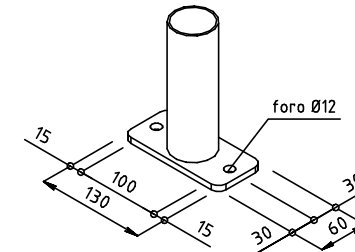
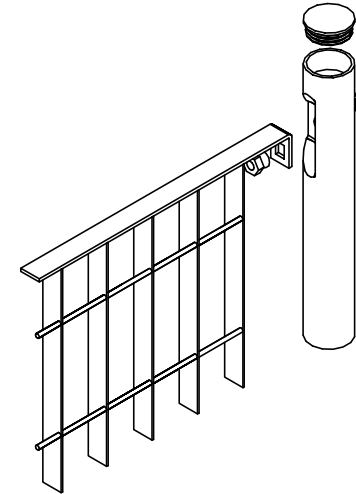
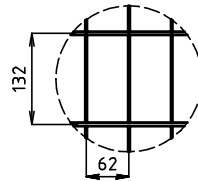

PIANTANA Ø50 lg. 1611 (da tassellare) kg/cad zn. 4,7
 DIMENSIONE PIASTRA 130x60x7

1	09-07-2013	MODIFICATO Ø TONDO ORIZZONTALE DA 5 A 4,5	BROGGI	M.G.
0	23-02-2013	PRIMA EMISSIONE	MARZORATI	M.G.
REVISIONE REVISION	DATA/DATE	DESCRIZIONE/DESCRIPTION	DIS./PREPARED	APPROV./APPROVED
			STEROPE 2 PANNELLO h.1458x1992 PIANTANA Ø50 lg.1758/1611	
22040 ANZANO DEL PARDO (CO) - Italia Tel: 031 63.32.211 r.a. - Fax: 031 63.32.233 www.nuovodefim.com e-mail: orsogrill@nuovodefim.com			ST2014 1 REVISIONE/REVISED 01	
CLIENTE CUSTOMER			Nuova Defim - Orsogrill	
QUESTO DISEGNO E' DI PROPRIETA' DELLA NUOVA DEFIM - ORSOGRILL ED E' VINCOLATO SECONDO LE NORME DI LEGGE. THIS DRAWING IS THE PROPERTY OF NUOVA DEFIM - ORSOGRILL WHO WILL SAFEGUARD ITS RIGHTS ACCORDING TO THE CIVIL AND PENAL PROVISIONS OF THE LAW.				SCALA SCALE 1/15

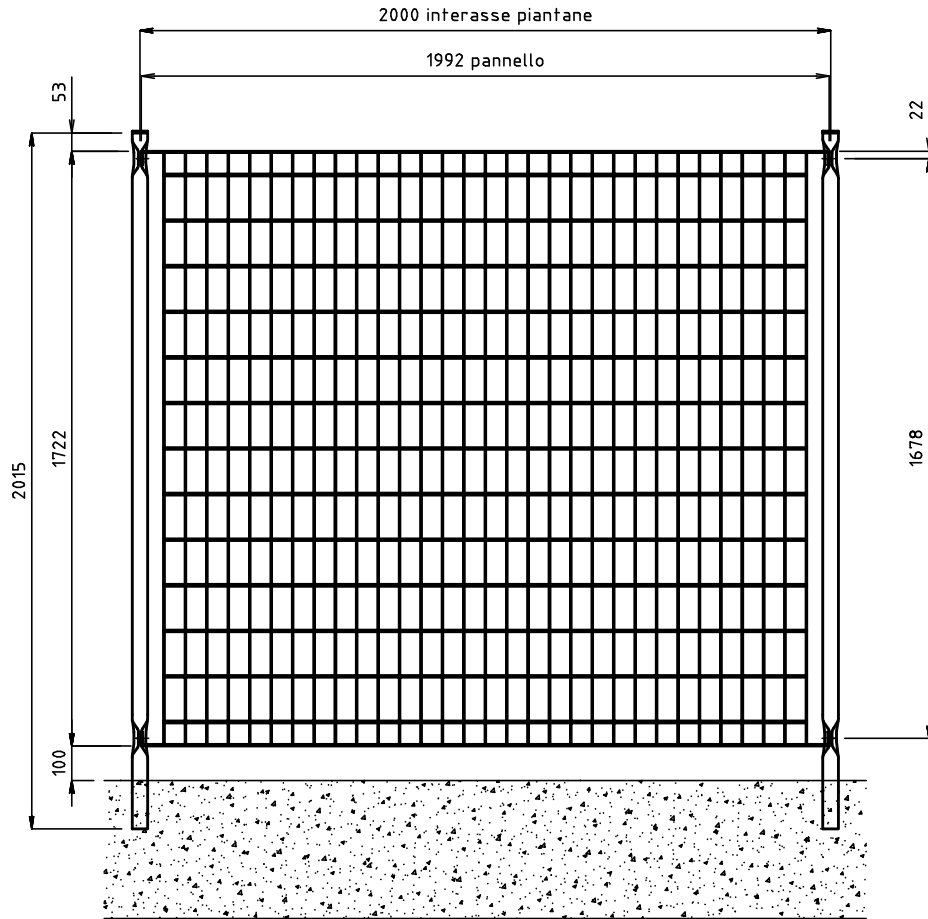

PANNELLO DA 1722x1992 kg/cad zn. 27,34 (kg/m² 7,97)
 #62x132
 PIATTO VERTICALE 25x2
 TONDO ORIZZONTALE Ø4,5
 CORNICE 25x4

PIANTANA Ø50 lg. 2015 (da inghisare) kg/cad zn. 5,2

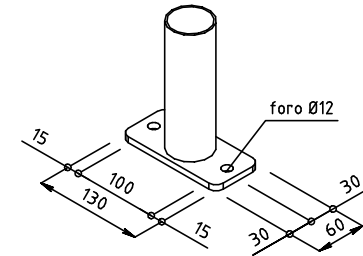
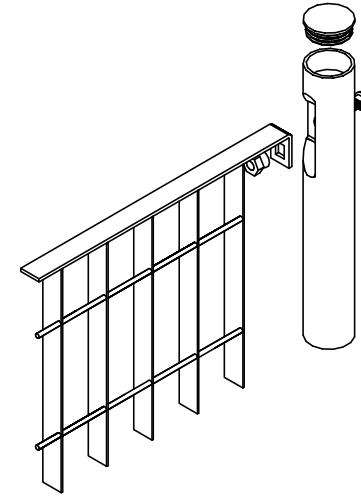
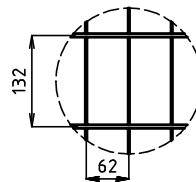

PIANTANA Ø50 lg. 1875 (da tassellare) kg/cad zn. 5,4
 DIMENSIONE PIASTRA 130x60x7

REVISIONE REVISION	DATA/DATE	DESCRIZIONE/DESCRIPTION	DIS./PREPARED	APPROV./APPROVED	FOGLIO SHEET
1	09-07-2013	MODIFICATO Ø TONDO ORIZZONTALE DA 5 A 4,5	BROGGI	M.G.	1
0	23-02-2013	PRIMA EMISSIONE	MARZORATI	M.G.	
STEROPE 2 PANNELLO h.1722x1992 PIANTANA Ø50 lg.2015/1875			ST2015		1
22040 ANZANO DEL PARGO (CO) - Italia Tel: 031 63.32.211 r.a. - Fax: 031 63.32.233 www.nuovodefim.com e-mail: onogri@nuovodefim.com			CLIENTE CUSTOMER		REVISIONE/REVISED 0/1
QUESTO DISEGNO E' DI PROPRIETA' DELLA NUOVA DEFIM - ORSOGRIL ED E' VINCOLATO SECONDO LE NORME DI LEGGE. THIS DRAWING IS THE PROPERTY OF NUOVA DEFIM - ORSOGRIL WHO WILL SAFEGUARD ITS RIGHTS ACCORDING TO THE CIVIL AND PENAL PROVISIONS OF THE LAW.					SCALA SCALE 1/15

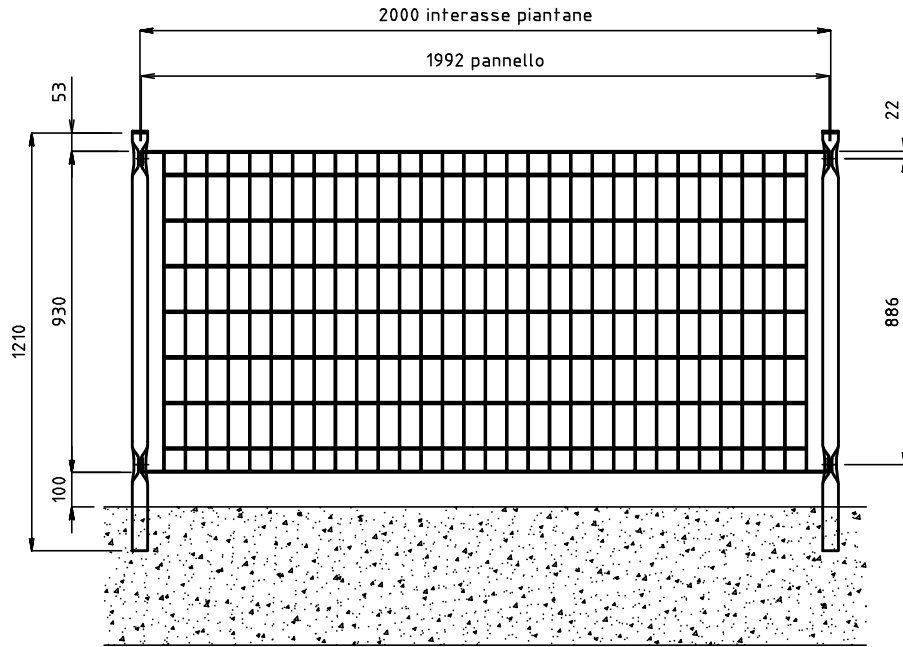

PANNELLO DA 930x1992 kg/cad zn. 21,91 (kg/m² 11,83)
 #62x132
 PIATTO VERTICALE 25x3
 TONDO ORIZZONTALE Ø4,5
 CORNICE 25x4
 PIANTANA Ø50 lg. 1210 (da inghisare) kg/cad zn. 3,1

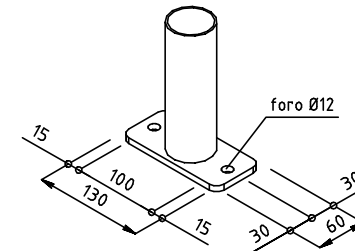
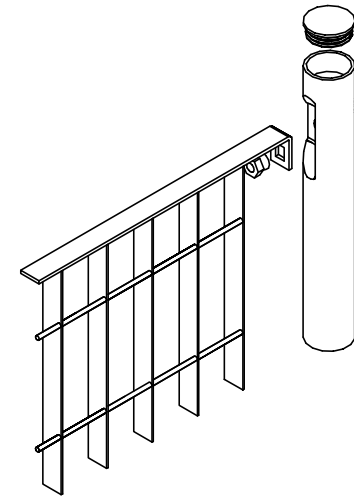
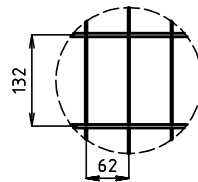

PIANTANA Ø50 lg. 1083 (da tassellare) kg/cad zn. 3,3
 DIMENSIONE PIASTRA 130x60x7

REVISIONE REVISION	DATA/DATE	DESCRIZIONE/DESCRIPTION	DIS./PREPARED	APPROV./APPROVED	FOGLIO SHEET
1	09-07-2013	MODIFICATO Ø TONDO ORIZZONTALE DA 5 A 4,5	BROGGI	M.G.	1
0	17-05-2013	PRIMA EMISSIONE	BROGGI	M.G.	
			STEROPE 3 PANNELLO h.930x1992 PIANTANA Ø50 lg.1210/1083		ST3081 REVISIONE/REVISED 0/1
22040 ANZANO DEL PARGO (CO) - Italia Tel. 031 63.32.211 r.a. - Fax. 031 63.32.233 www.nuovodefim.com e-mail: orsogrill@nuovodefim.com			CLIENTE CUSTOMER Nuova Defim - Orsogrill		SCALA SCALE 1/15
<small>QUESTO DISEGNO E' DI PROPRIETA' DELLA NUOVA DEFIM - ORSOGRILL ED E' VINCOLATO SECONDO LE NORME DI LEGGE. THIS DRAWING IS THE PROPERTY OF NUOVA DEFIM - ORSOGRILL WHO WILL SAFEGUARD ITS RIGHTS ACCORDING TO THE CIVIL AND PENAL PROVISIONS OF THE LAW. Disegno eseguito con CAD. Non Revisionare manualmente./Drawing made by CAD. Do not modify manually.</small>					

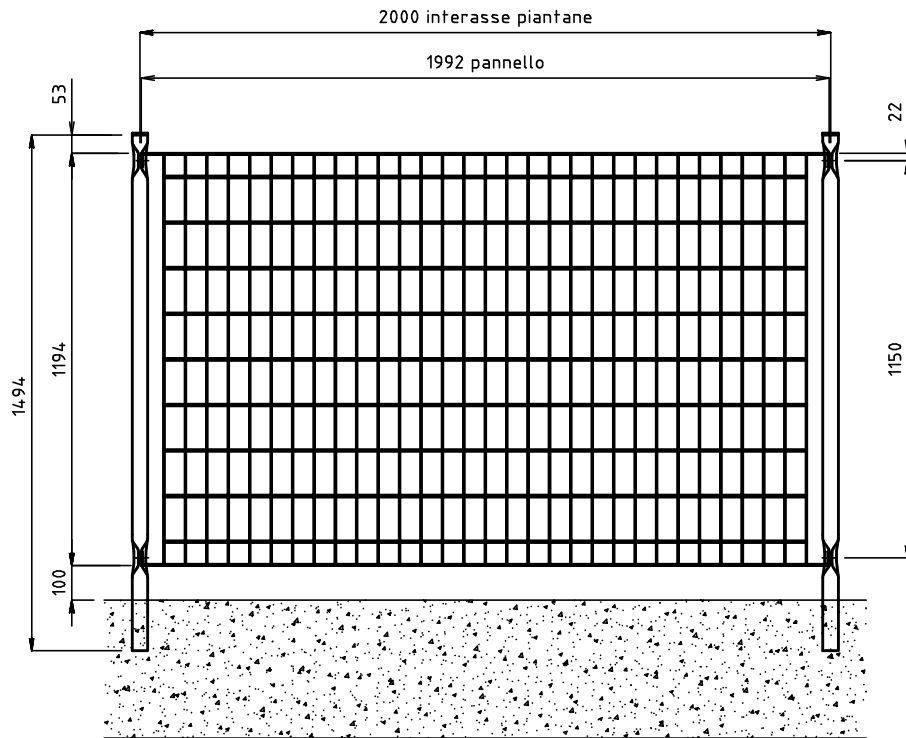

PANNELLO DA 1194x1992 kg/cad zn. 27,21 (kg/m² 11,44)
 #62x132
 PIATTO VERTICALE 25x3
 TONDO ORIZZONTALE Ø4,5
 CORNICE 25x4

PIANTANA Ø50 lg. 1494 (da inghisare) kg/cad zn. 3,9

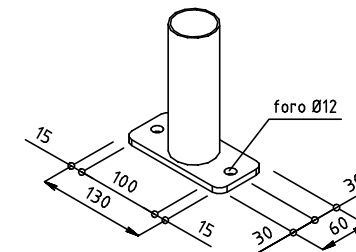
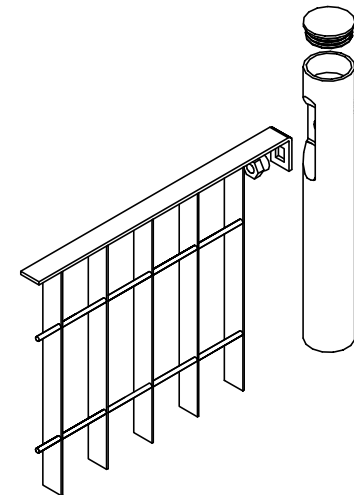
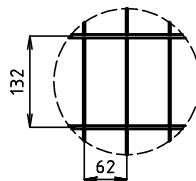

PIANTANA Ø50 lg. 1347 (da tassellare) kg/cad zn.4,0
 DIMENSIONE PIASTRA 130x60x7

1	09-07-2013	MODIFICATO Ø TONDO ORIZZONTALE DA 5 A 4,5	BROGGI	M.G.
0	17-05-2013	PRIMA EMISSIONE	BROGGI	M.G.
REVISIONE REVISION	DATA/DATE	DESCRIZIONE/DESCRIPTION	DIS./PREPARED	APPROV./APPROVED
			STEROPE 3 PANNELLO h.1194x1992 PIANTANA Ø50 lg.1494/1347	
22040 ANZANO DEL PARCO (CO) - Italia Tel. 031 63.32.211 r.a. - Fax. 031 63.32.233 www.nuovodefim.com e-mail: orsogril@nuovodefim.com			ST3082 1 REVISIONE/REVISED Ø1	
CLIENTE/CUSTOMER: Nuova Defim - Orsogril			COMM. JOB:	
QUESTO DISEGNO E' DI PROPRIETA' DELLA NUOVA DEFIM - ORSOGRIL ED E' VINCOLATO SECONDO LE NORME DI LEGGE. THIS DRAWING IS THE PROPERTY OF NUOVA DEFIM - ORSOGRIL WHO WILL SAFEGUARD ITS RIGHTS ACCORDING TO THE CIVIL AND PENAL PROVISIONS OF THE LAW.				
Disegno eseguito con CAD. Non Revisionare manualmente./Drawing made by CAD. Do not modify manually.				SCALA SCALE: 1/15

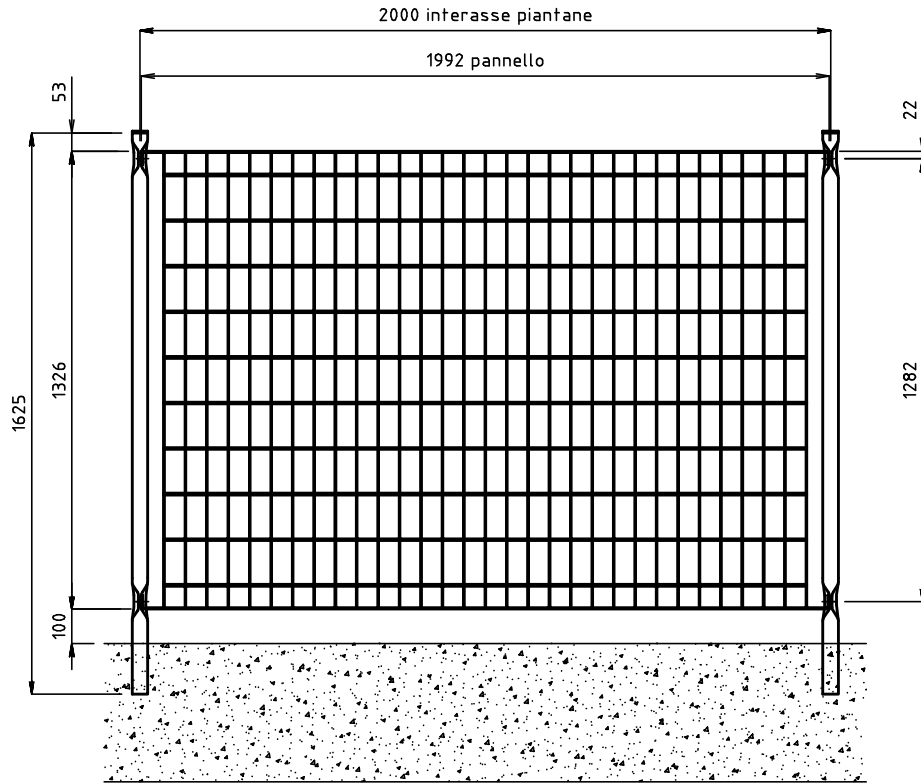

PANNELLO DA 1326x1992 kg/cad zn. 29,87 (kg/m² 11,31)
 #62x132
 PIATTO VERTICALE 25x3
 TONDO ORIZZONTALE Ø4,5
 CORNICE 25x4

PIANTANA Ø50 lg. 1625 (da inghisare) kg/cad zn. 4,2

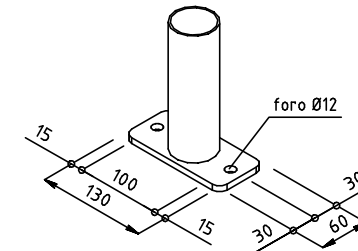
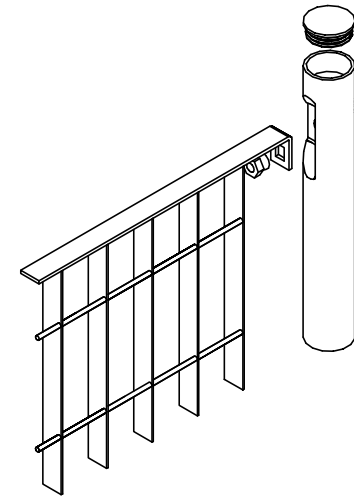
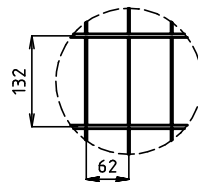

PIANTANA Ø50 lg. 1479 (da tassellare) kg/cad zn. 4,4
 DIMENSIONE PIASTRA 130x60x7

1	09-07-2013	MODIFICATO Ø TONDO ORIZZONTALE DA 5 A 4,5	BROGGI	M.G.
0	17-05-2013	PRIMA EMISSIONE	BROGGI	M.G.
REVISIONE REVISION	DATA/DATE	DESCRIZIONE/DESCRIPTION	DIS./PREPARED	APPROV./APPROVED
		STEROPE 3 PANNELLO h.1326x1992 PIANTANA Ø50 lg.1625/1479	DIS./DWG.N° ST3083	FOGLIO SHEET 1
22040 ANZANO DEL PARCO (CO) - Italia Tel. 031 63.32.211 r.a. - Fax. 031 63.32.233 www.nuovodefim.com e-mail: orsogrill@nuovodefim.com		CLIENTE CUSTOMER Nuova Defim - Orsogrill	REVISIONE/REVISED 01	COMM. JOB
<small>QUESTO DISEGNO E' DI PROPRIETA' DELLA NUOVA DEFIM - ORSOGRILL ED E' VINCOLATO SECONDO LE NORME DI LEGGE. THIS DRAWING IS THE PROPERTY OF NUOVA DEFIM - ORSOGRILL WHO WILL SAFEGUARD ITS RIGHTS ACCORDING TO THE CIVIL AND PENAL PROVISIONS OF THE LAW.</small>				SCALA SCALE 1/15

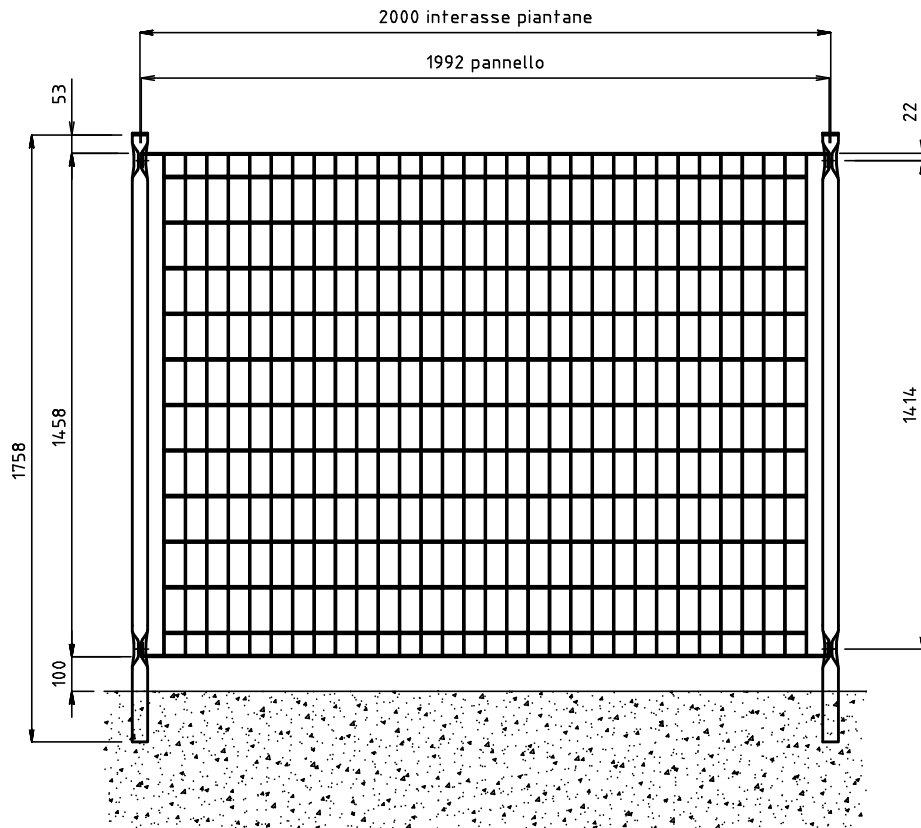

PANNELLO DA 1458x1992 kg/cad zn. 32,53 (kg/m² 11,20)
 #62x132
 PIATTO VERTICALE 25x3
 TONDO ORIZZONTALE Ø4,5
 CORNICE 25x4
 PIANTANA Ø50 lg. 1758 (da inghisare) kg/cad zn. 4,6

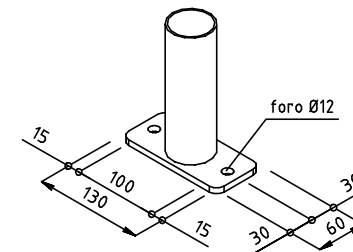
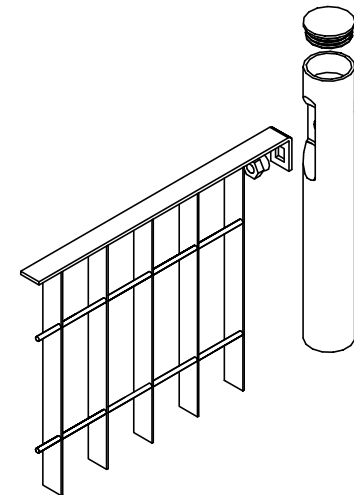
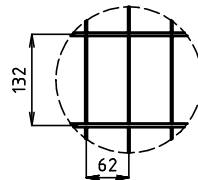

PIANTANA Ø50 lg. 1611 (da tassellare) kg/cad zn. 4,7
 DIMENSIONE PIASTRA 130x60x7

1	09-07-2013	MODIFICATO Ø TONDO ORIZZONTALE DA 5 A 4,5	BROGGI	M.G.
0	17-05-2013	PRIMA EMISSIONE	BROGGI	M.G.
REVISIONE REVISION	DATA/DATE	DESCRIZIONE/DESCRIPTION	DIS./PREPARED	APPROV./APPROVED
			STEROPE 3 PANNELLO h.1458x1992 PIANTANA Ø50 lg.1758/1611	
22040 ANZANO DEL PARCO (CO) - Italia Tel. 031 63.32.211 r.a. - Fax. 031 63.32.233 www.nuovodefim.com e-mail: orsogril@nuovodefim.com			ST3084 1 REVISIONE/REVISED 01	
CLIENTE CUSTOMER			Nuova Defim - Orsogril COMM. JOB	
QUESTO DISEGNO E' DI PROPRIETA' DELLA NUOVA DEFIM - ORSOGRIL ED E' VINCOLATO SECONDO LE NORME DI LEGGE. THIS DRAWING IS THE PROPERTY OF NUOVA DEFIM - ORSOGRIL WHO WILL SAFEGUARD ITS RIGHTS ACCORDING TO THE CIVIL AND PENAL PROVISIONS OF THE LAW.				SCALA SCALE 1/15

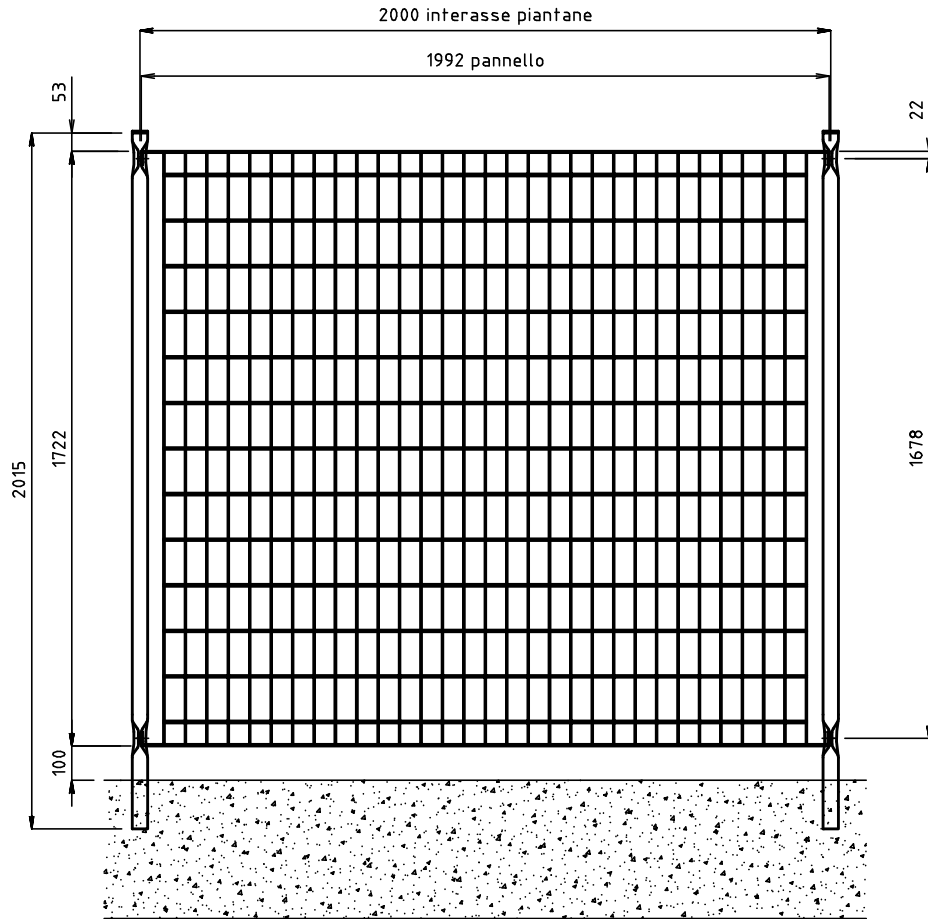

PANNELLO DA 1722x1992 kg/cad zn. 37,84 (kg/m² 11,03)
 #62x132
 PIATTO VERTICALE 25x3
 TONDO ORIZZONTALE Ø4,5
 CORNICE 25x4

PIANTANA Ø50 lg. 2015 (da inghisare) kg/cad zn. 5,2

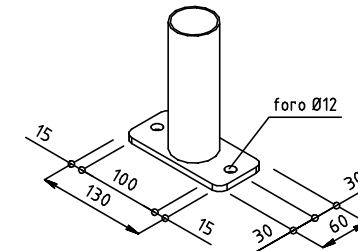
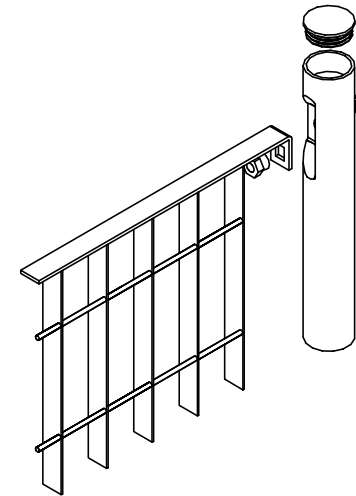
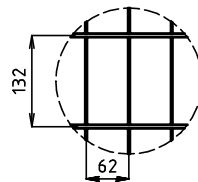

PIANTANA Ø50 lg. 1875 (da tassellare) kg/cad zn. 5,4
 DIMENSIONE PIASTRA 130x60x7

1	09-07-2013	MODIFICATO Ø TONDO ORIZZONTALE DA 5 A 4,5	BROGGI	M.G.
0	17-05-2013	PRIMA EMISSIONE	BROGGI	M.G.
REVISIONE REVISION	DATA/DATE	DESCRIZIONE/DESCRIPTION	DIS./PREPARED	APPROV./APPROVED
			STEROPE 3 PANNELLO h.1722x1992 PIANTANA Ø50 lg.2015/1875	
22040 ANZANO DEL PARCO (CO) - Italia Tel. 031 63.32.211 r.a. - Fax. 031 63.32.233 www.nuovodefim.com e-mail: onogri@nuovodefim.com			ST3085 1 REVISIONE/REVISED 01	
QUESTO DISEGNO E' DI PROPRIETA' DELLA NUOVA DEFIM - ORSOGRIL ED E' VINCOLATO SECONDO LE NORME DI LEGGE. THIS DRAWING IS THE PROPERTY OF NUOVA DEFIM - ORSOGRIL WHO WILL SAFEGUARD ITS RIGHTS ACCORDING TO THE CIVIL AND PENAL PROVISIONS OF THE LAW.			CLIENTE CUSTOMER SCALA SCALE 1/15	